

## Inline™ Manifolds Ordering Information

---

**Mold Mounted Manifolds provide many benefits to the operation and performance of the water cooled process. Our manifolds offer a myriad of combinations to suit your needs.**

---

### STANDARD MANIFOLDS

1. Choose your manifold from the following pages.
2. Stock Manifolds will ship same day or by the next business day.

### WHEN ORDERING CUSTOM MANIFOLDS

1. Submit design or sketch.
2. Cito will make CAD drawing and submit via fax with price quote and delivery information.
3. Upon approval of drawing, the manifold will be shipped the following week.

### TO ORDER YOUR DESIGN KIT FOR INLINE MANIFOLDS

Our Design Kit will assist in your mold or machine mounted design of Inline™ Manifolds — complete with CAD Patterns, and custom order forms.

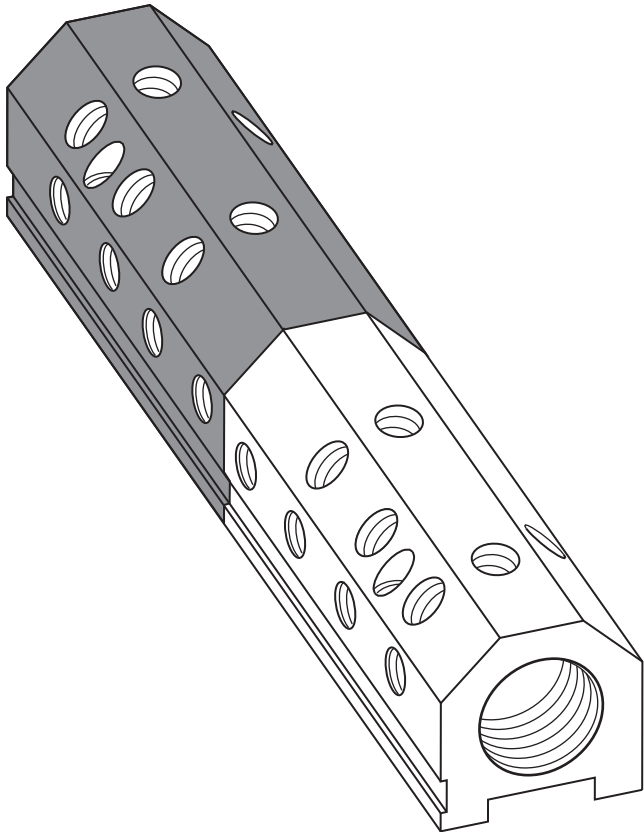

Please contact our Sales Department  
**CITO PRODUCTS INC.**

N8779 County Road X • P.O. Box 90

Watertown, WI 53094 • USA

Phone: (920) 261-2606

Fax: (920) 261-1350

E-mail: [sales@pulsecooling.com](mailto:sales@pulsecooling.com)

ATTENTION: SALES DEPARTMENT

**Please specify which CAD system you are using when requesting your Design Kit.**

The Design Kit is available in:

.PRT (CadKey)

.DWG (AutoCad)

.DXF (Data Exchange Format)

.IGES (International Graphic Exchange)

The anodized aluminum is not suitable for corrosive liquids (high chlorine content).  
Brass, steel and stainless is available. Request quote.

# 3/4" Inline™ Manifold - 1 = 1/4"

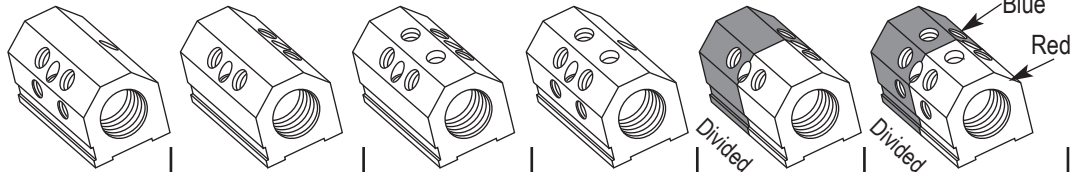
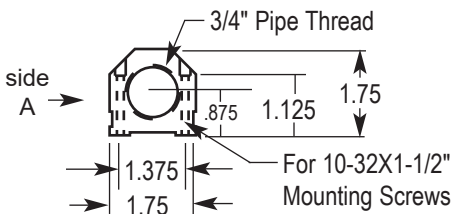
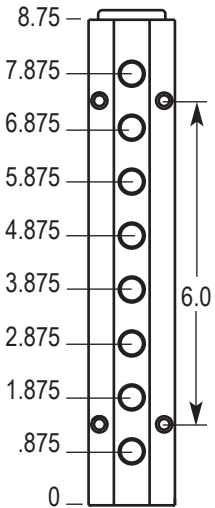
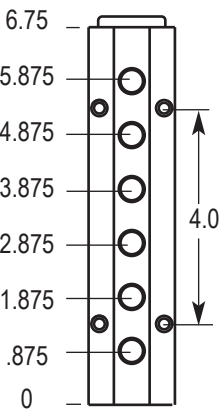
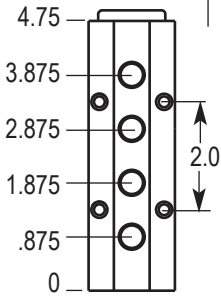
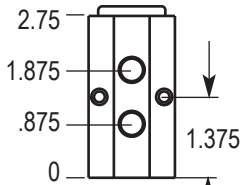

IM3-2-AB-4 1/8 or 1/4 \$60.00  
 IM3-2-BD-4 1/8 or 1/4 \$60.00  
 IM3-2-BCD-6 1/8 or 1/4 \$66.00  
 IM3-2-ABC-6 1/8 or 1/4 \$66.00  
 IM3-2-BD-2-2 1/8 or 1/4 \$74.00  
 IM3-2-ABCDE-5-5 1/8 \$92.00

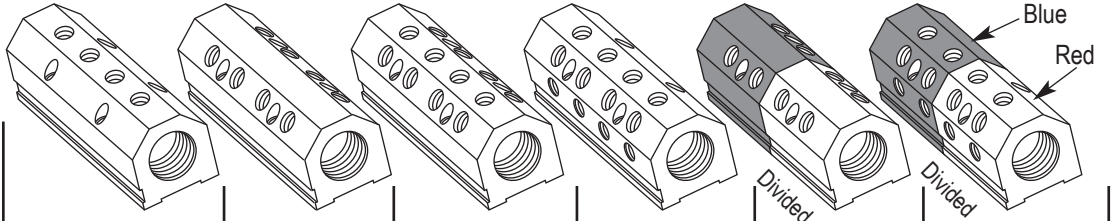

IM3-4-C-4 1/8 or 1/4 \$72.00  
 IM3-4-BD-8 1/8 or 1/4 \$84.00  
 IM3-4-BCD-12 1/8 or 1/4 \$84.00  
 IM3-4-ABC-12 1/8 or 1/4 \$96.00  
 IM3-4-BD-4-4 1/8 or 1/4 \$98.00  
 IM3-4-ABC-6-6 1/8 or 1/4 \$110.00

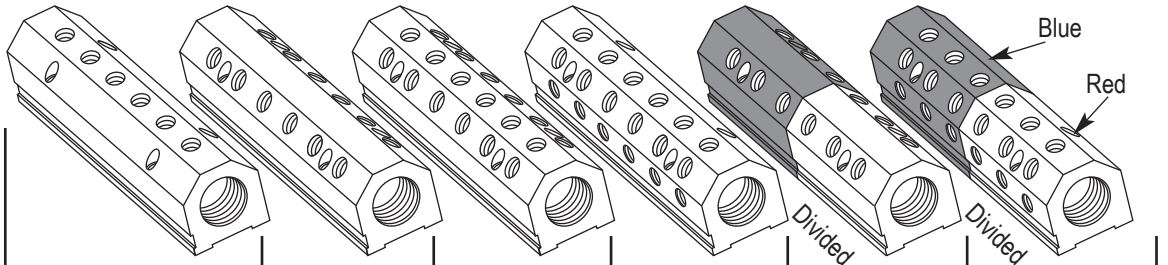

IM3-6-C-6 1/8 or 1/4 \$90.00  
 IM3-6-BD-12 1/8 or 1/4 \$108.00  
 IM3-6-BCD-18 1/8 or 1/4 \$126.00  
 IM3-6-ABC-18 1/8 or 1/4 \$126.00  
 IM3-6-BD-6-6 1/8 or 1/4 \$122.00  
 IM3-6-ABC-9-9 1/8 or 1/4 \$140.00

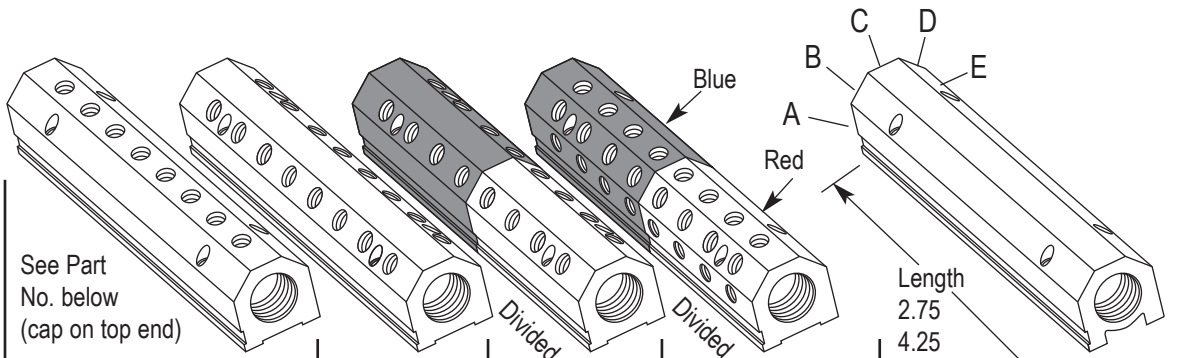

See Part No. below (cap on top end)

IM3-8-C-8 1/8 or 1/4 \$108.00  
 IM3-8-BD-16 1/8 or 1/4 \$132.00  
 IM3-8-BD-8-8 1/8 or 1/4 \$146.00  
 IM3-8-ABC-12-12 1/8 \$170.00

PART NUMBER CODE:

**IM3-8-C-8-1/4-N-BLUE**

Red, Blue or Divided  
 Thread Type: N=NPT  
 1/4" "Out"  
 8 Holes  
 Row on side "C"  
 8 = 8.750" Overall Length  
 (3) x 1/4" = 3/4" Port  
 Inline Manifold

3/4" NPT

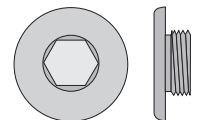

For Solid Color Manifolds  
**PRICES INCLUDE:** End Cap and Stainless mounting screws.  
 ADDITIONAL 3/4" MANIFOLD END CAPS: IM-3030 - \$10.00 ea.  
**CUSTOM MANIFOLDS QUOTED UPON REQUEST**

The anodized aluminum is not suitable for corrosive liquids (high chlorine content)

CITO-FP-PRICE-24-0124

# 1" Inline™ Manifold - 1 = 1/4"

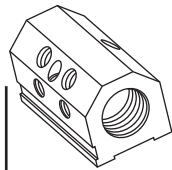
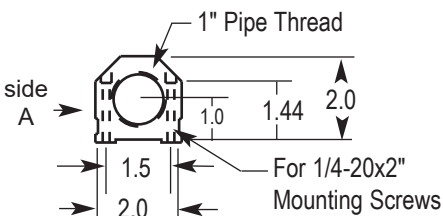
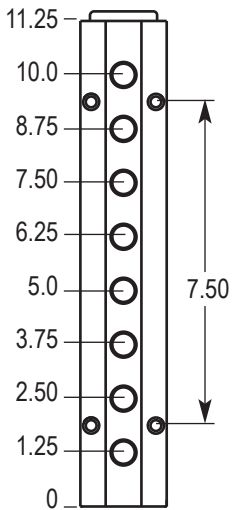
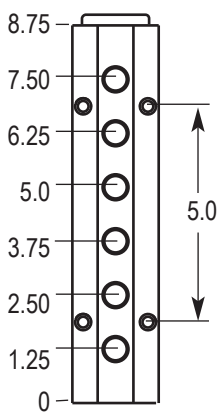
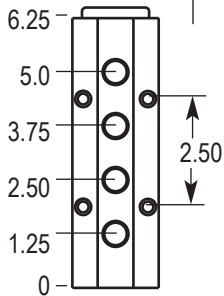
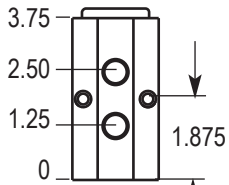

IM4-4-AB-4  
1/4 or 3/8  
\$72.00

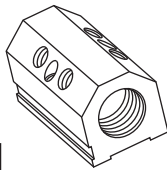

IM4-4-BD-4  
1/4 or 3/8  
\$72.00

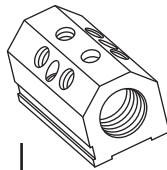

IM4-4-BCD-6  
1/4 or 3/8  
\$78.00

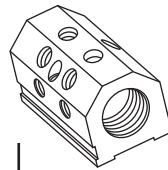

IM4-4-ABC-6  
1/4 or 3/8  
\$78.00

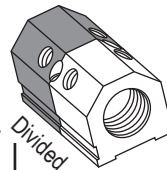

IM4-4-BD-2-2  
1/4 or 3/8  
\$90.00

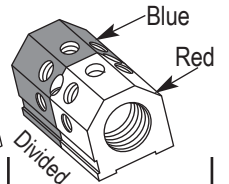

IM4-4-ABCDE-5-5  
1/4  
\$108.00

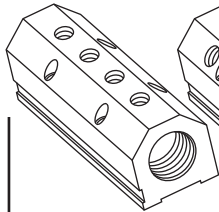

IM4-6-C-4  
1/4 or 3/8  
\$93.00

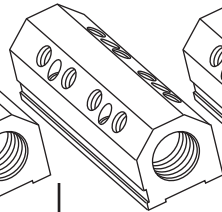

IM4-6-BD-8  
1/4 or 3/8  
\$105.00

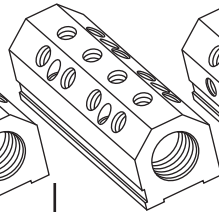

IM4-6-BCD-12  
1/4 or 3/8  
\$117.00

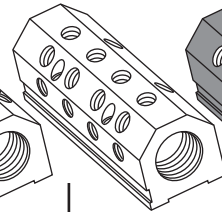

IM4-6-ABC-12  
1/4 or 3/8  
\$117.00

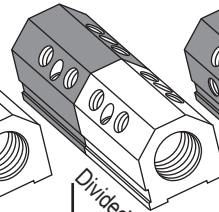

IM4-6-BD-4-4  
1/4 or 3/8  
\$123.00

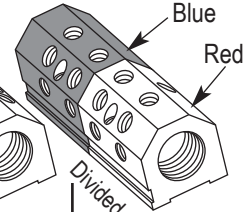

IM4-6-ABC-6-6  
1/4 or 3/8  
\$135.00

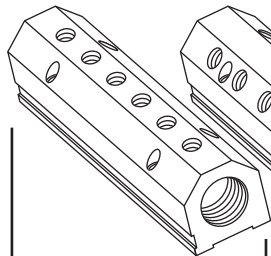

IM4-9-C-6  
1/4 or 3/8  
\$113.00

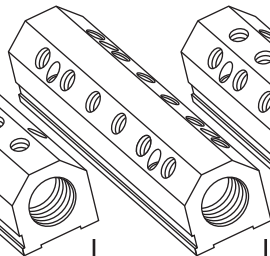

IM4-9-BD-12  
1/4 or 3/8  
\$131.00

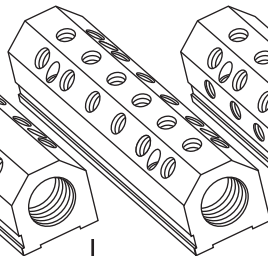

IM4-9-BCD-18  
1/4 or 3/8  
\$149.00

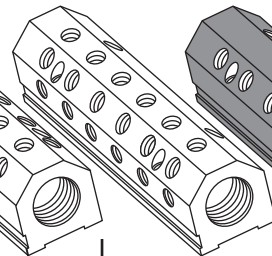

IM4-9-ABC-18  
1/4 or 3/8  
\$149.00

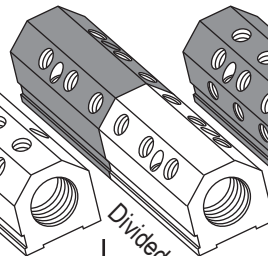

IM4-9-BD-6-6  
1/4 or 3/8  
\$149.00

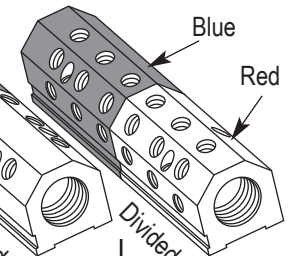

IM4-9-ABC-9-9  
1/4 or 3/8  
\$167.00

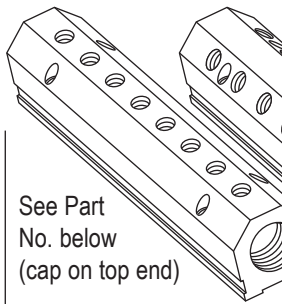

IM4-11-C-8  
1/4 or 3/8  
\$140.00

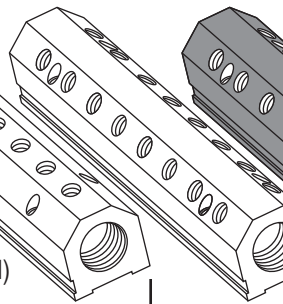

IM4-11-BD-16  
1/4 or 3/8  
\$164.00

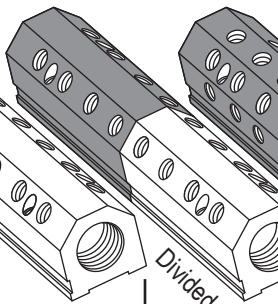

IM4-11-BD-8-8  
1/4 or 3/8  
\$182.00

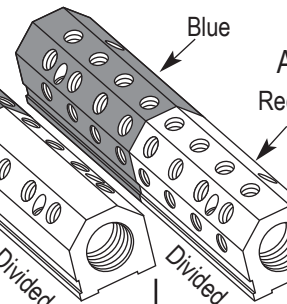

IM4-11-ABC-12-12  
1/4 or 3/8  
\$206.00

See Part No. below (cap on top end)

PART NUMBER CODE:

**IM4-11-C-8-3/8-N-BLUE**

Red, Blue or Divided  
Thread Type: N=NPT  
P=Mark BSPP  
T=Mark BSPT  
8 Holes  
Row on side "C"  
11 = 11.25" Overall Length  
(4) x 1/4" = 1" Port  
Inline Manifold

1" NPT

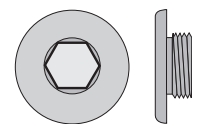

For Solid Color Manifolds  
**PRICES INCLUDE:** End Cap and Stainless mounting screws.  
ADDITIONAL 1" MANIFOLD END CAPS: IM-3040 - \$12.00 ea.  
**CUSTOM MANIFOLDS QUOTED UPON REQUEST**

CITO-FP-PRICE-22-0812

The anodized aluminum is not suitable for corrosive liquids (high chlorine content)

# 1-1/4" Inline™ Manifold - 1 = 1/4"

Technical drawings on the left show manifold profiles with dimensions: 2.25, 3.0, 1.5, 0, 7.5, 6.0, 4.5, 3.0, 1.5, 0, 10.5, 9.0, 7.5, 6.0, 4.5, 3.0, 1.5, 0, 13.5, 12.0, 10.5, 9.0, 7.5, 6.0, 4.5, 3.0, 1.5, 0, and 9.0.

IM5-5-AB-4 1/4 or 3/8 \$92.00	IM5-5-BD-4 1/4 or 3/8 \$92.00	IM5-5-BCD-6 1/4 or 3/8 \$100.00	IM5-5-ABC-6 1/4 or 3/8 \$100.00	IM5-5-BD-2-2 1/4 or 3/8 \$110.00	IM5-5-ABCDE-5-5 1/4 or 3/8 \$134.00
IM5-8-C-4 1/4 or 3/8 \$116.00	IM5-8-BD-8 1/4 or 3/8 \$132.00	IM5-8-BCD-12 1/4 or 3/8 \$148.00	IM5-8-ABC-12 1/4 or 3/8 \$148.00	IM5-8-BD-4-4 1/4 or 3/8 \$150.00	IM5-8-ABC-6-6 1/4 or 3/8 \$166.00
IM5-11-C-6 1/4 or 3/8 \$148.00	IM5-11-BD-12 1/4 or 3/8 \$172.00	IM5-11-BCD-18 1/4 or 3/8 \$196.00	IM5-11-ABC-18 1/4 or 3/8 \$196.00	IM5-11-BD-6-6 1/4 or 3/8 \$190.00	IM5-11-ABC-9-9 1/4 or 3/8 \$214.00
IM5-14-C-8 1/4 or 3/8 \$180.00	IM5-14-BD-16 1/4 or 3/8 \$212.00	IM5-14-BD-8-8 1/4 or 3/8 \$230.00	IM5-14-ABC-12-12 1/4 or 3/8 \$262.00	See Part No. below (cap on top end)	

**PART NUMBER CODE:**  
**IM5-14-C-8-3/8-N-BLUE**

- IM5 - In-line Manifold
- 14 - 14 = 13.5" Overall Length
- C - Row on side "C"
- 8 - 8 Holes
- 3/8 - 3/8" "Out"
- N - Thread Type: N=NPT
- BLUE - Red, Blue or Divided
- (5) x 1/4" = 1-1/4" Port

Red, Blue or Divided  
 Thread Type: N=NPT  
 P=Mark BSPP  
 T=Mark BSPT

1-1/4" NPT

For Solid Color Manifolds  
**PRICES INCLUDE:** End Cap and Stainless mounting screws.  
 ADDITIONAL 1-1/4" MANIFOLD END CAPS: IM-3050 - \$14.00 ea.  
**CUSTOM MANIFOLDS QUOTED UPON REQUEST**

CITO-FP-PRICE-24-0213

The anodized aluminum is not suitable for corrosive liquids (high chlorine content)

# 1-1/2" Inline™ Manifold - 1 = 1/4"

Length (inches)	Part Number	Thread Type	Price
6.0	IM6-6-AB-4	3/8 or 1/2	\$106.00
	IM6-6-BD-4	3/8 or 1/2	\$106.00
	IM6-6-BCD-6	3/8 or 1/2	\$116.00
	IM6-6-ABC-6	3/8 or 1/2	\$116.00
	IM6-6-BD-2-2	3/8 or 1/2	\$126.00
	IM6-6-ABCDE-5-5	3/8 or 1/2	\$156.00
10.0	IM6-10-C-4	3/8 or 1/2	\$142.00
	IM6-10-BD-8	3/8 or 1/2	\$162.00
	IM6-10-BCD-12	3/8 or 1/2	\$182.00
	IM6-10-ABC-12	3/8 or 1/2	\$182.00
	IM6-10-BD-4-4	3/8 or 1/2	\$182.00
	IM6-10-ABC-6-6	3/8 or 1/2	\$202.00
14.0	IM6-14-C-6	3/8 or 1/2	\$188.00
	IM6-14-BD-12	3/8 or 1/2	\$218.00
	IM6-14-BCD-18	3/8 or 1/2	\$248.00
	IM6-14-ABC-18	3/8 or 1/2	\$248.00
	IM6-14-BD-6-6	3/8 or 1/2	\$238.00
	IM6-14-ABC-9-9	3/8 or 1/2	\$268.00
18.0	IM6-18-C-8	3/8 or 1/2	\$234.00
	IM6-18-BD-16	3/8 or 1/2	\$274.00
	IM6-18-BD-8-8	3/8 or 1/2	\$294.00
	IM6-18-ABC-12-12	3/8 or 1/2	\$334.00

See Part No. below (cap on top end)

PART NUMBER CODE:  
**IM6-18-C-8-3/8-N-BLUE**

Red, Blue or Divided  
Thread Type: N=NPT  
P=Mark BSPP  
T=Mark BSPT  
3/8" "Out"  
8 Holes  
Row on side "C"  
18 = 18" Overall Length  
(6) x 1/4" = 1-1/2" Port  
Inline Manifold

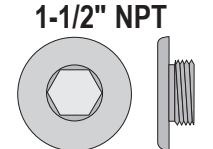

**1-1/2" NPT**  
For Solid Color Manifolds  
**PRICES INCLUDE:** End Cap and Stainless mounting screws.  
ADDITIONAL 1-1/2" MANIFOLD END CAPS: IM-3060 - \$16.00 ea.  
**CUSTOM MANIFOLDS QUOTED UPON REQUEST**

The anodized aluminum is not suitable for corrosive liquids (high chlorine content)

CITO-FP-PRICE-22-0812

# 2" Inline™ Manifold - 1 = 1/4"

**Dimensions:**

- Row 1: 7.0" total height, 3.5" port diameter, 0" to 4.75" port spacing.
- Row 2: 12.0" total height, 5.0" port diameter, 0" to 7.25" port spacing.
- Row 3: 17.0" total height, 10.0" port diameter, 0" to 12.25" port spacing.
- Row 4: 22.0" total height, 15.0" port diameter, 0" to 19.75" port spacing.

**Part Numbers and Prices:**

- IM8-8-ACE-6: 1/2, 3/4 or 1, \$154.00
- IM8-8-ABCDE-10: 1/2 or 3/4, \$178.00
- IM8-12-C-4: 1/2, 3/4 or 1, \$182.00
- IM8-12-BD-8: 1/2, 3/4 or 1, \$206.00
- IM8-12-ABC-12: 1/2 or 3/4, \$230.00
- IM8-12-ABC-6-6: 1/2 or 3/4, \$256.00
- IM8-17-C-6: 1/2, 3/4 or 1, \$244.00
- IM8-17-BD-12: 1/2, 3/4 or 1, \$280.00
- IM8-17-ABC-18: 1/2 or 3/4, \$316.00
- IM8-17-BD-6-6: 1/2, 3/4 or 1, \$306.00
- IM8-17-ABC-9-9: 1/2 or 3/4, \$342.00
- IM8-22-C-8: 1/2, 3/4 or 1, \$306.00
- IM8-22-BD-16: 1/2, 3/4 or 1, \$354.00
- IM8-22-BD-8-8: 1/2, 3/4 or 1, \$380.00
- IM8-22-ABC-12-12: 1/2 or 3/4, \$428.00

**Color Options:** Blue, Red, Divided

**Thread Type:** N=NPT, P=Mark BSPP, T=Mark BSPT

**Part Number Code:** IM8-22-C-6-1/2-N-BLUE

- IM8: Inline Manifold
- 22: 22" Overall Length
- C: Row on side "C"
- 6: 6 Holes
- 1/2: 1/2" "Out"
- N: Thread Type: N=NPT
- BLUE: Red, Blue or Divided

**2" NPT**

For Solid Color Manifolds  
**PRICES INCLUDE:** End Cap and Stainless mounting screws.  
**ADDITIONAL 2" MANIFOLD END CAPS:** IM-3080 - \$18.00 ea.  
**CUSTOM MANIFOLDS QUOTED UPON REQUEST**

CITO-FP-PRICE-22-0812

The anodized aluminum is not suitable for corrosive liquids (high chlorine content)

# 3/4" x 5" Sideline™ Manifold - 1 = 1/4"

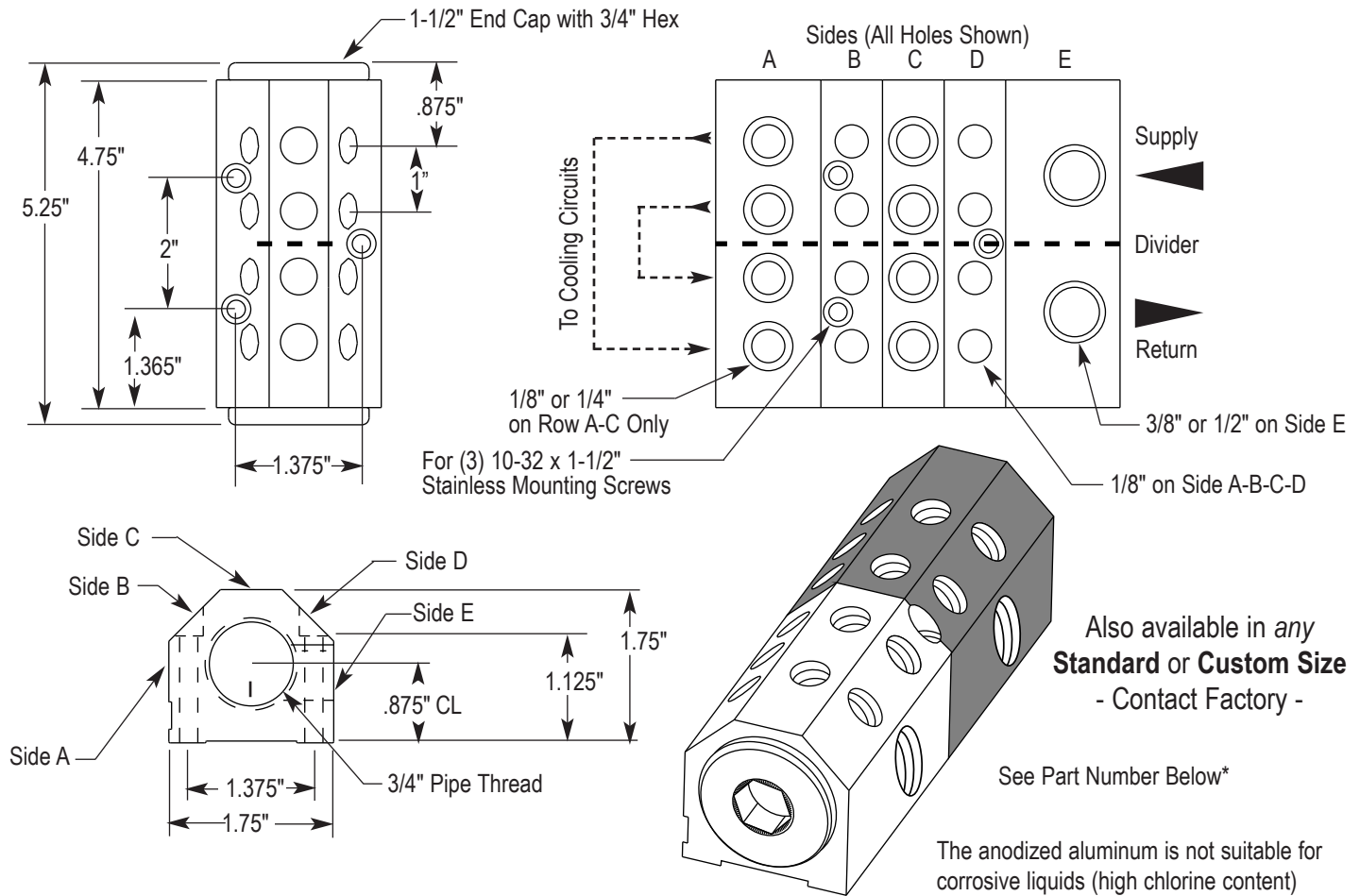

Outgoing Ports					Part Number	Price
Side A In/Out	Side B In/Out	Side C In/Out	Side D In/Out	Side E - Return In/Out		
	(2) (2) 1/8"-1/8"			3/8"-3/8"	IM3S-5-3/8-B-2-2-1/8-N-R/B	\$112.00
(2) (2) 1/8"-1/8"	(2) (2) 1/8"-1/8"			3/8"-3/8"	IM3S-5-3/8-AB-4-4-1/8-N-R/B	\$124.00
	(2) (2) 1/8"-1/8"		(2) (2) 1/8"-1/8"	3/8"-3/8"	*IM3S-5-3/8-BD-4-4-1/8-N-R/B	\$124.00
	(2) (2) 1/8"-1/8"	(2) (2) 1/8"-1/8"	(2) (2) 1/8"-1/8"	3/8"-3/8"	IM3S-5-3/8-BCD-6-6-1/8-N-R/B	\$136.00
(2) (2) 1/8"-1/8"	(2) (2) 1/8"-1/8"	(2) (2) 1/8"-1/8"	(2) (2) 1/8"-1/8"	3/8"-3/8"	IM3S-5-3/8-ABCD-8-8-1/8-N-R/B	\$148.00
	(2) (2) 1/4"-1/4"			1/2"-1/2"	IM3S-5-1/2-B-2-2-1/4-N-R/B	\$112.00
	(2) (2) 1/4"-1/4"		(2) (2) 1/4"-1/4"	1/2"-1/2"	IM3S-5-1/2-BD-4-4-1/4-N-R/B	\$124.00

PRICE INCLUDES: End Caps and (3) 10-32 x 1-1/2" ST. ST. Mtg. Screws. ADDITIONAL 3/4" End Caps \$8.00 ea.

\*Part Number Code:

**IM3S-5-3/8-BD-4-4-1/8-N-R/B**

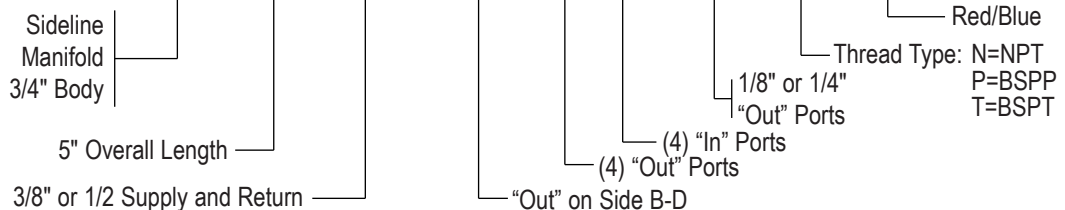

# 1" x 7" Sideline™ Manifold - 1 = 1/4"

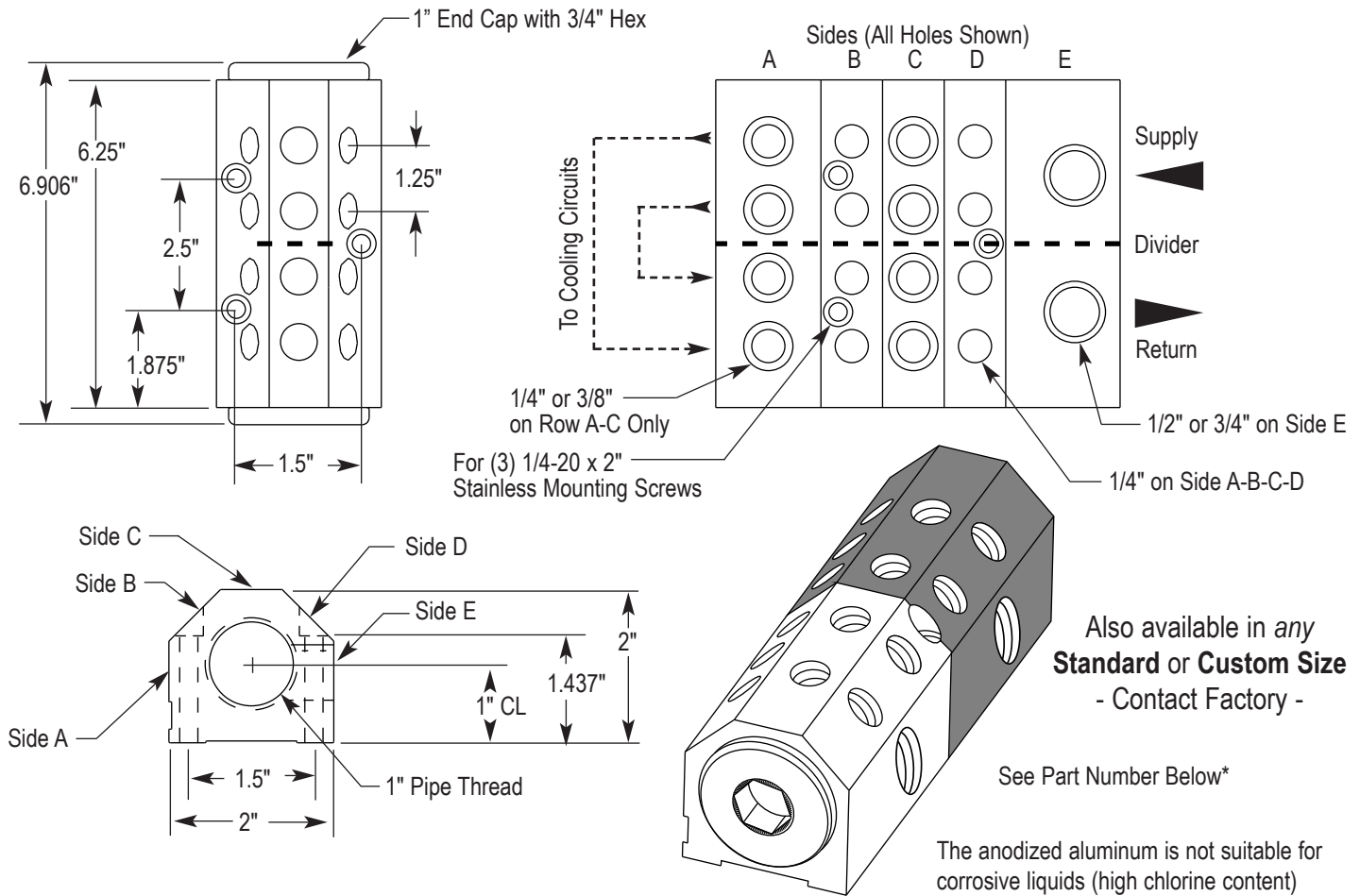

Outgoing Ports					Part Number	Price
Side A In/Out	Side B In/Out	Side C In/Out	Side D In/Out	Side E - Return In/Out		
	(2) (2) 1/4"-1/4"			1/2"-1/2"	IM4S-7-1/2-B-2-2-1/4-N-R/B	\$137.00
(2) (2) 1/4"-1/4"	(2) (2) 1/4"-1/4"			1/2"-1/2"	IM4S-7-1/2-AB-4-4-1/4-N-R/B	\$149.00
	(2) (2) 1/4"-1/4"		(2) (2) 1/4"-1/4"	1/2"-1/2"	IM4S-7-1/2-BD-4-4-1/4-N-R/B	\$149.00
	(2) (2) 1/4"-1/4"	(2) (2) 1/4"-1/4"	(2) (2) 1/4"-1/4"	1/2"-1/2"	*IM4S-7-1/2-BCD-6-6-1/4-N-R/B	\$161.00
(2) (2) 1/4"-1/4"	(2) (2) 1/4"-1/4"	(2) (2) 1/4"-1/4"	(2) (73) 1/4"-1/4"	1/2"-1/2"	IM4S-7-1/2-ABCD-8-8-1/4-N-R/B	\$173.00
	(2) (2) 3/8"-3/8"			3/4"-3/4"	IM4S-7-3/4-B-2-2-3/8-N-R/B	\$137.00
	(2) (2) 3/8"-3/8"		(2) (2) 3/8"-3/8"	3/4"-3/4"	IM4S-7-3/4-BD-4-4-3/8-N-R/B	\$149.00

PRICE INCLUDES: End Caps and (3) 1/4-20x2" ST. ST. Mtg. Screws. ADDITIONAL 1" End Caps \$10.00 ea.

\*Part Number Code:

## IM4S-7-1/2-BCD-6-6-1/4-N-R/B

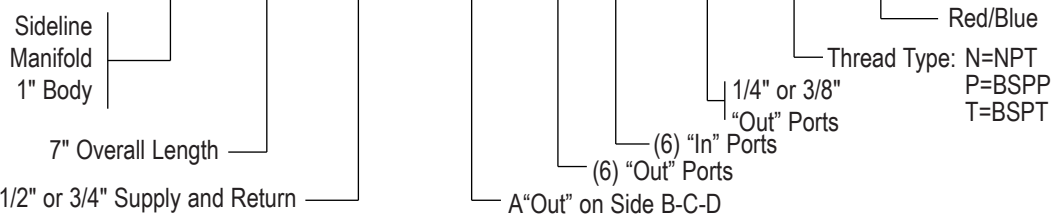

CITO-FP-PRICE-22-0812



# 1-1/4" x 8" Sideline™ Manifold - 1 = 1/4"

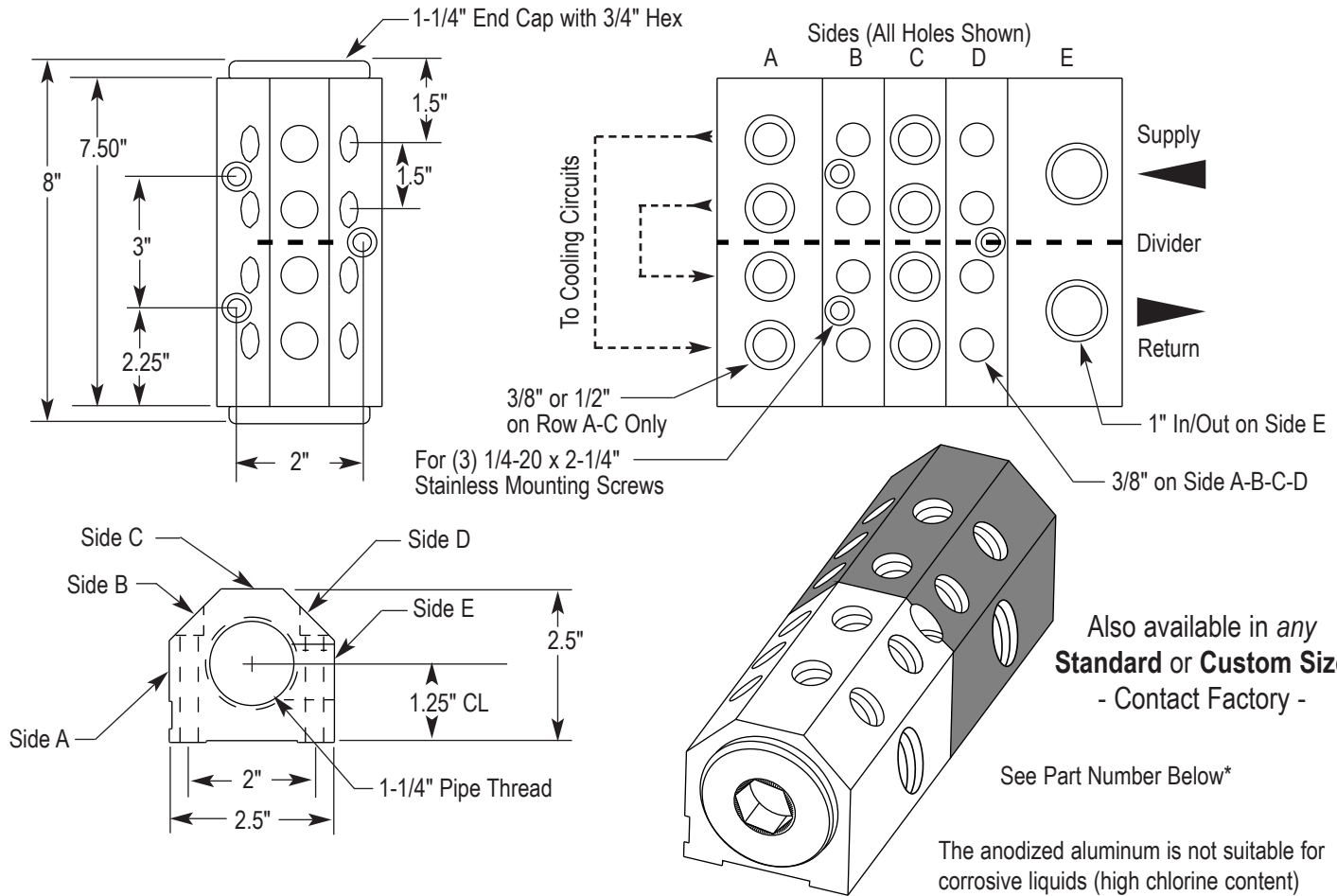

Outgoing Ports					Part Number	Price
Side A In/Out	Side B In/Out	Side C In/Out	Side D In/Out	Side E - Return In/Out		
	(2) (2) 3/8"-3/8"			1"-1"	IM5S-8-1-B-2-2-3/8-N-R/B	\$166.00
(2) (2) 3/8"-3/8"	(2) (2) 3/8"-3/8"			1"-1"	IM5S-8-1-AB-4-4-3/8-N-R/B	\$182.00
	(2) (2) 3/8"-3/8"		(2) (2) 3/8"-3/8"	1"-1"	IM5S-8-1-BD-4-4-3/8-N-R/B	\$182.00
	(2) (2) 3/8"-3/8"	(2) (2) 3/8"-3/8"	(2) (2) 3/8"-3/8"	1"-1"	IM5S-8-1-ABC-6-6-3/8-N-R/B	\$198.00
(2) (2) 3/8"-3/8"	(2) (2) 3/8"-3/8"	(2) (2) 3/8"-3/8"	(2) (2) 3/8"-3/8"	1"-1"	*IM5S-8-1-ABCD-8-8-3/8-N-R/B	\$214.00
	(2) (2) 1/2"-1/2"			1"-1"	IM5S-8-1-B-2-2-1/2-N-R/B	\$166.00
	(2) (2) 1/2"-1/2"		(2) (2) 1/2"-1/2"	1"-1"	IM5S-8-1-BD-4-4-1/2-N-R/B	\$182.00

PRICE INCLUDES: End Caps and (3) 1/4-20 x 2-1/4" ST. ST. Mtg. Screws. ADDITIONAL 1-1/4" End Caps \$12.00 ea.

\*Part Number Code:

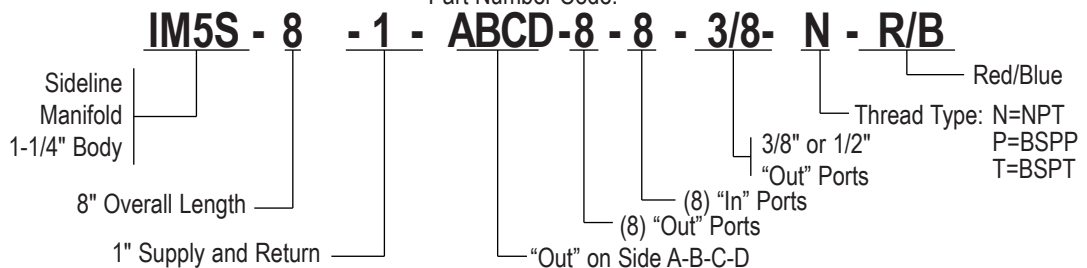

# 1-1/2" x 10" Sideline™ Manifold - 1 = 1/4"

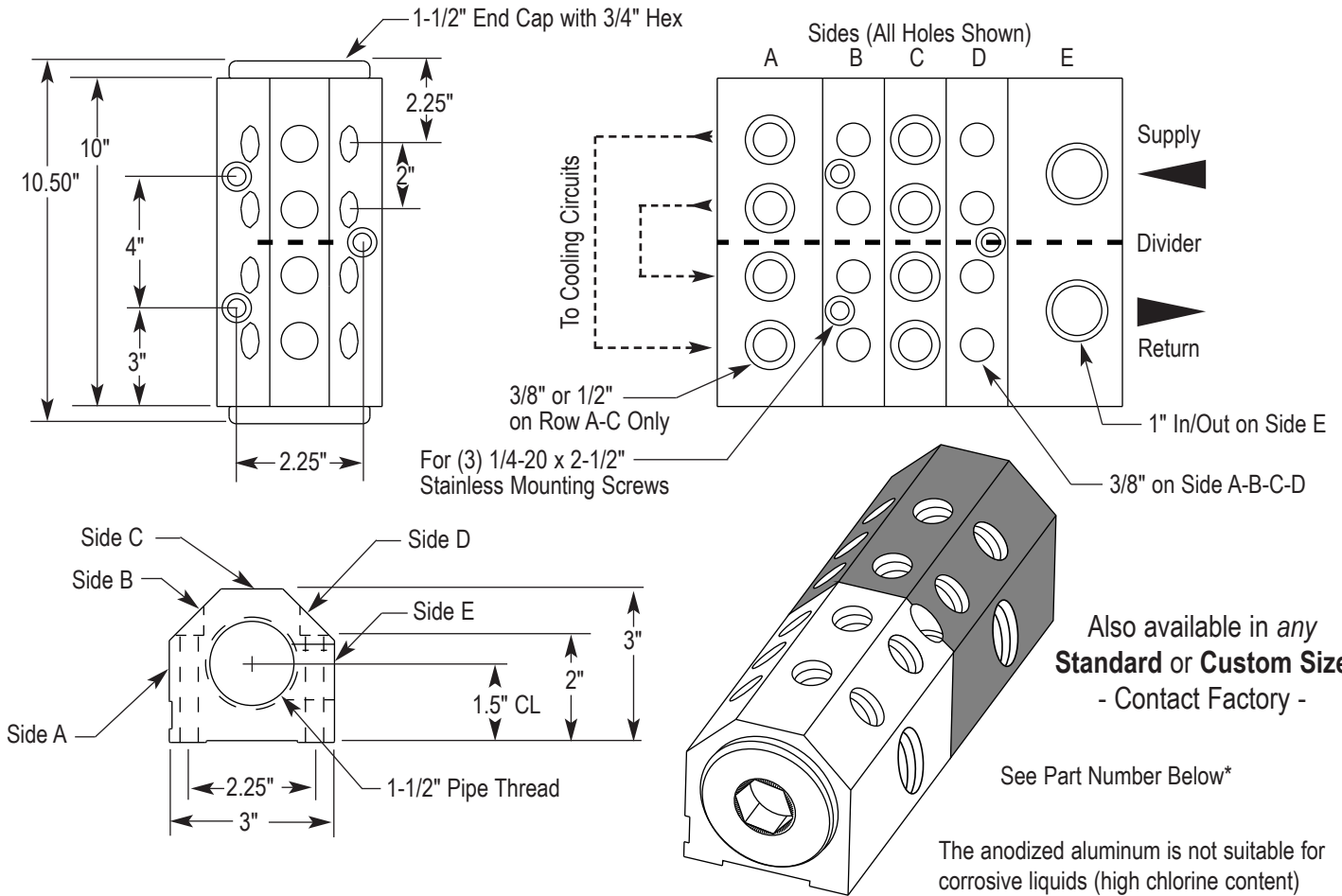

Outgoing Ports					Part Number	Price
Side A In/Out	Side B In/Out	Side C In/Out	Side D In/Out	Side E - Return In/Out		
	(2) (2) 3/8"-3/8"			1"-1"	IM6S-10-1-B-2-2-3/8-N-R/B	\$200.00
(2) (2) 3/8"-3/8"	(2) (2) 3/8"-3/8"			1"-1"	IM6S-10-1-AB-4-4-3/8-N-R/B	\$220.00
	(2) (2) 3/8"-3/8"		(2) (2) 3/8"-3/8"	1"-1"	IM6S-10-1-BD-4-4-3/8-N-R/B	\$240.00
	(2) (2) 3/8"-3/8"	(2) (2) 3/8"-3/8"	(2) (2) 3/8"-3/8"	1"-1"	IM6S-10-1-ABC-6-6-3/8-N-R/B	\$240.00
(2) (2) 3/8"-3/8"	(2) (2) 3/8"-3/8"	(2) (2) 3/8"-3/8"	(2) (2) 3/8"-3/8"	1"-1"	*IM6S-10-1-ABCD-8-8-3/8-N-R/B	\$260.00
	(2) (2) 1/2"-1/2"			1"-1"	IM6S-10-1-B-2-2-1/2-N-R/B	\$200.00
	(2) (2) 1/2"-1/2"		(2) (2) 1/2"-1/2"	1"-1"	IM6S-10-1-BD-4-4-1/2-N-R/B	\$220.00

PRICE INCLUDES: End Caps and (3) 1/4-20 x 2-1/2" ST. ST. Mtg. Screws. ADDITIONAL 1-1/2" End Caps \$14.00 ea.

\*Part Number Code:

**IM6S - 10 - 1 - ABCD - 8 - 8 - 3/8 - N - R/B**

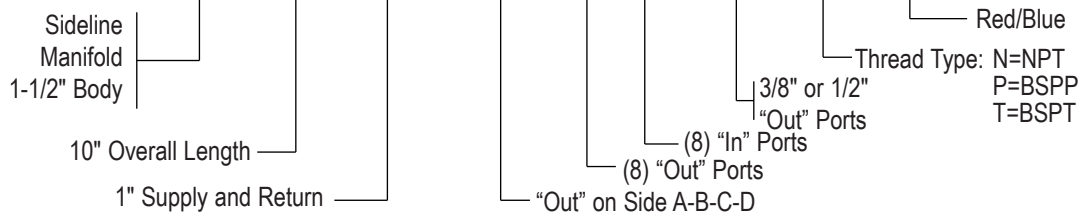

CITO-FP-PRICE-22-0812

# 2" x 12" Sideline™ Manifold - 1 = 1/4"

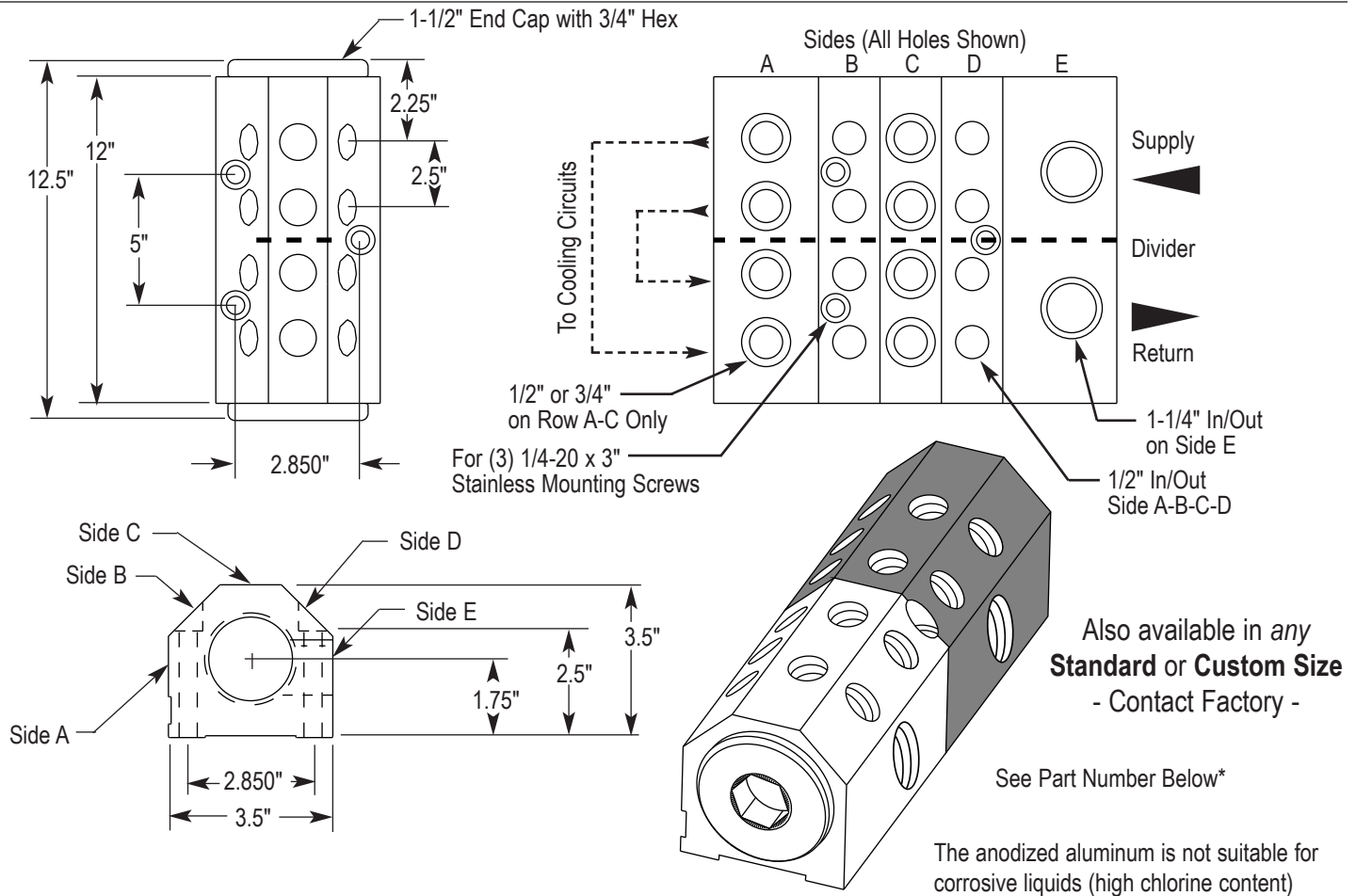

Outgoing Ports					Part Number	Price
Side A In/Out	Side B In/Out	Side C In/Out	Side D In/Out	Side E - Return In/Out		
	(2) (2) 1/2"-1/2"			1-1/4"-1-1/4"	IM8S-12-1-1/4-B-2-2-1/2-N-R/B	\$252.00
(2) (2) 1/2"-1/2"	(2) (2) 1/2"-1/2"			1-1/4"-1-1/4"	IM8S-12-1-1/4-AB-4-4-1/2-N-R/B	\$276.00
	(2) (2) 1/2"-1/2"		(2) (2) 1/2"-1/2"	1-1/4"-1-1/4"	IM8S-12-1-1/4-BD-4-4-1/2-N-R/B	\$276.00
	(2) (2) 1/2"-1/2"	(2) (2) 1/2"-1/2"	(2) (2) 1/2"-1/2"	1-1/4"-1-1/4"	IM8S-12-1-1/4-BCD-6-6-1/2-N-R/B	\$300.00
(2) (2) 1/2"-1/2"	(2) (2) 1/2"-1/2"	(2) (2) 1/2"-1/2"	(2) (2) 1/2"-1/2"	1-1/4"-1-1/4"	*IM8S-12-1-1/4-ABCD-8-8-1/2-N-R/B	\$324.00
	(2) (2) 3/4"-3/4"			1-1/4"-1-1/4"	IM8S-12-1-1/4-B-2-2-3/4-N-R/B	\$252.00
	(2) (2) 3/4"-3/4"		(2) (2) 3/4"-3/4"	1-1/4"-1-1/4"	IM8S-12-1-1/4-BD-4-4-3/4-N-R/B	\$276.00

PRICE INCLUDES: End Caps and 1/4" - 20 x 3" ST. ST. Mtg. Screws. ADDITIONAL 2" End Caps \$16.00 ea.

\*Part Number Code: **IM8S-12-1-1/4-ABCD-8-8-3/8-N-R/B**

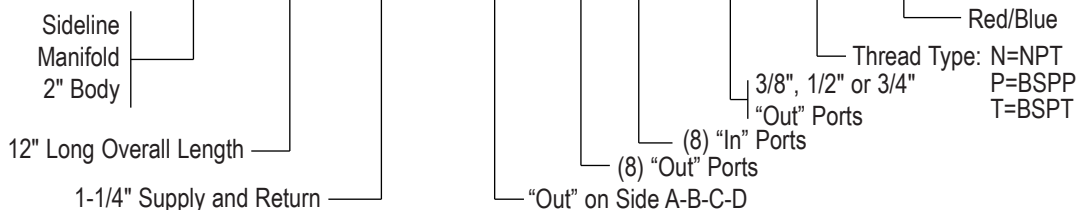

CITO-FP-PRICE-22-0812

# BottomLine™ Custom Mold Mounted Manifold

Submit your requirements for pricing and delivery  
**CITO PRODUCTS INC.**  
 ATTENTION: SALES DEPARTMENT

CITO will submit drawing and assign part number to your models

## 3/4" IB3

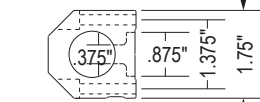

3/8" Hole Diameter  
 # 310 "O" Ring  
 ORDER # IB3-XXXX-XX

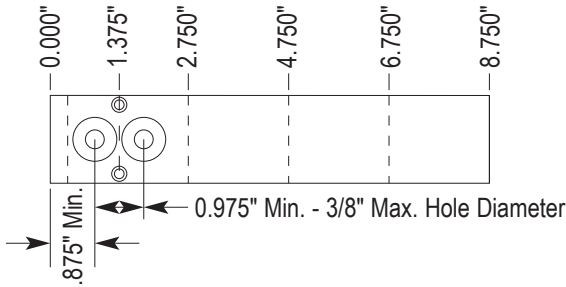

## 1" IB4

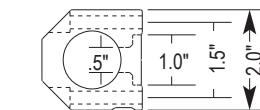

1/2" Hole Diameter  
 # 312 "O" Ring  
 ORDER # IB4-XXXX-XX

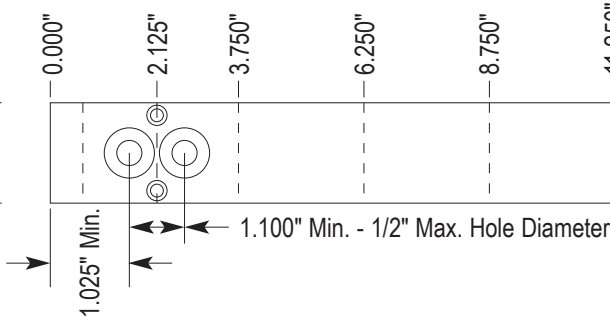

## IB4-02NB-01

InLine	Zones	Serial
	3 = 3/4"	R - Red
	4 = 1"	B - Blue
	5 = 1-1/4"	
	6 = 1-1/2"	
	8 = 2"	
Bottomline	N = National Pipe Taper (USA) P = Parallel Pipe T = Tapered Pipe	

## 1-1/4" IB5

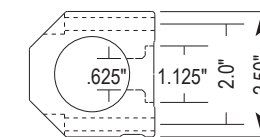

5/8" Hole Diameter  
 # 314 "O" Ring  
 ORDER # IB5-XXXX-XX

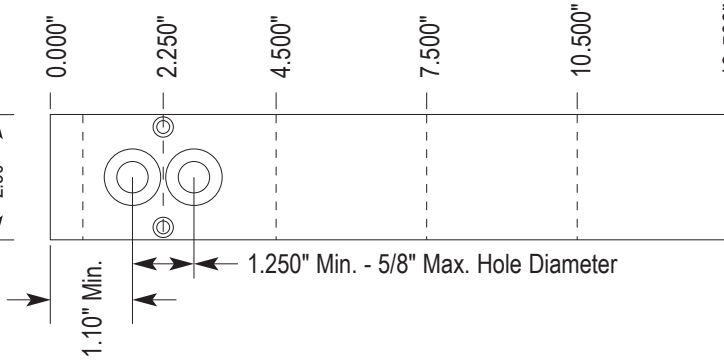

## 1-1/2" IB6

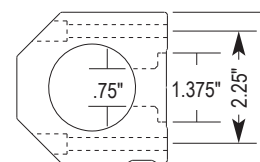

3/4" Hole Diameter  
 # 318 "O" Ring  
 ORDER # IB6-XXXX-XX

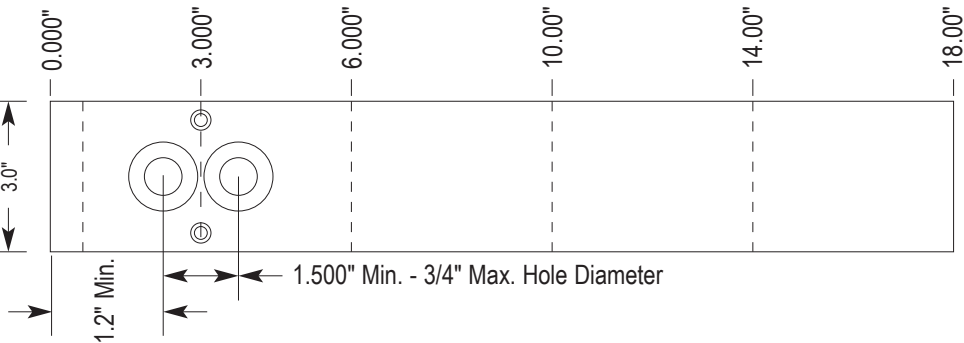

## 2" IB8

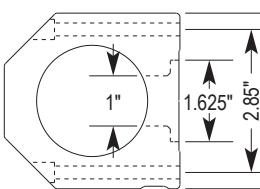

1" Hole Diameter  
 # 322 "O" Ring  
 ORDER # IB8-XXXX-XX

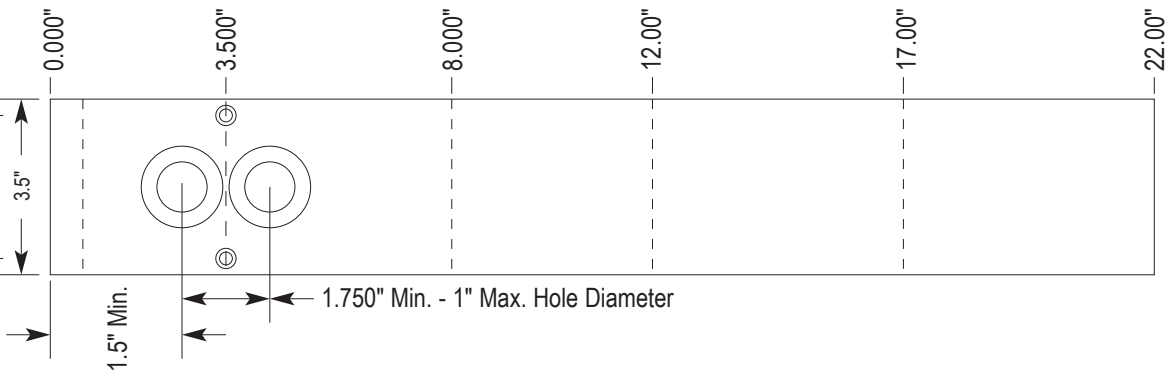

CITO-FP-PRICE-23-1120

# RotoLine™ Flow Indicating Manifold

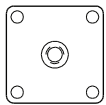

(1) 1/8" EC-2011

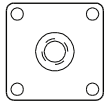

(1) 1/4" EC-2021

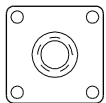

(1) 3/8" EC-2031

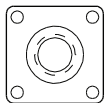

(1) 1/2" EC-2041

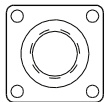

(1) 3/4" EC-2061

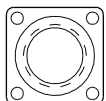

(1) 1" EC-2081

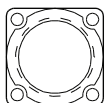

(1) 1-1/4" EC-2101

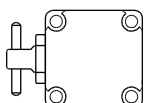

Valve Cap  
1/4" - VC-2902  
3/8" - VC-2903  
1/2" - VC-2904

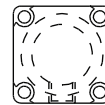
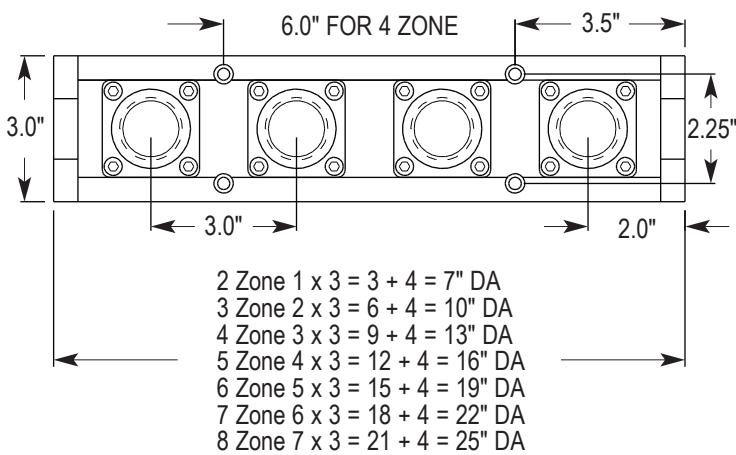

1/4" Side EC-220S

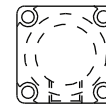

3/8" Side EC-230S

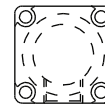

1/2" Side EC-240S



1/4" End EC-22TE-TCK

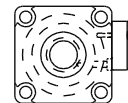

3/8" End EC-23TE-TCK

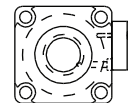

1/2" End EC-24TE-TCK

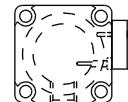

1/4" End EC-22TS-TCK

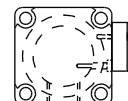

3/8" Side EC-23TS-TCK

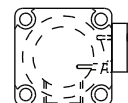

1/2" Side EC-24TS-TCK

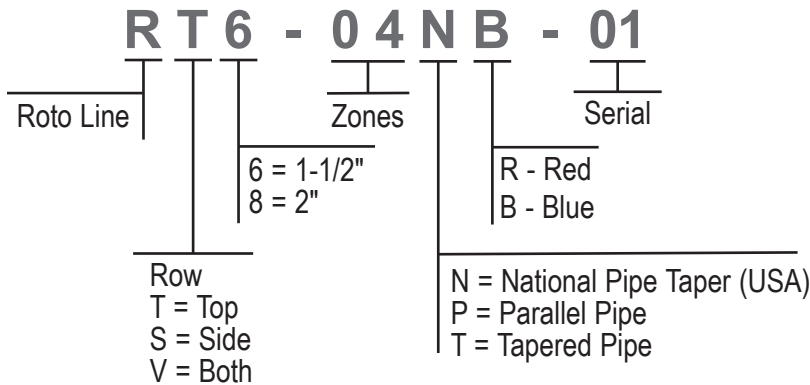
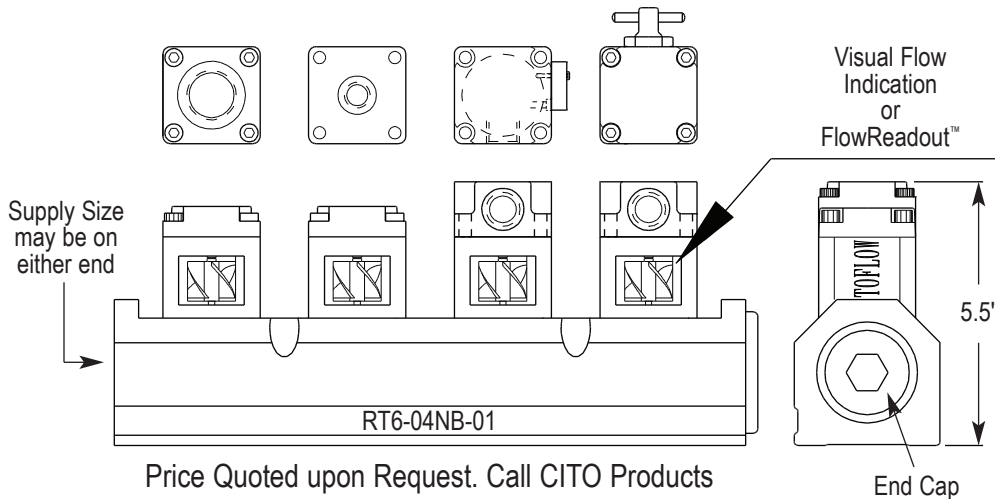

**CITO PRODUCTS**  
WILL ASSIGN MODEL NUMBER TO EACH CUSTOM ASSEMBLY

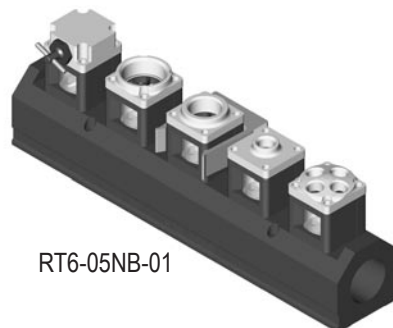

CITO-FP-PRICE-22-1004

# Flow Restrictions

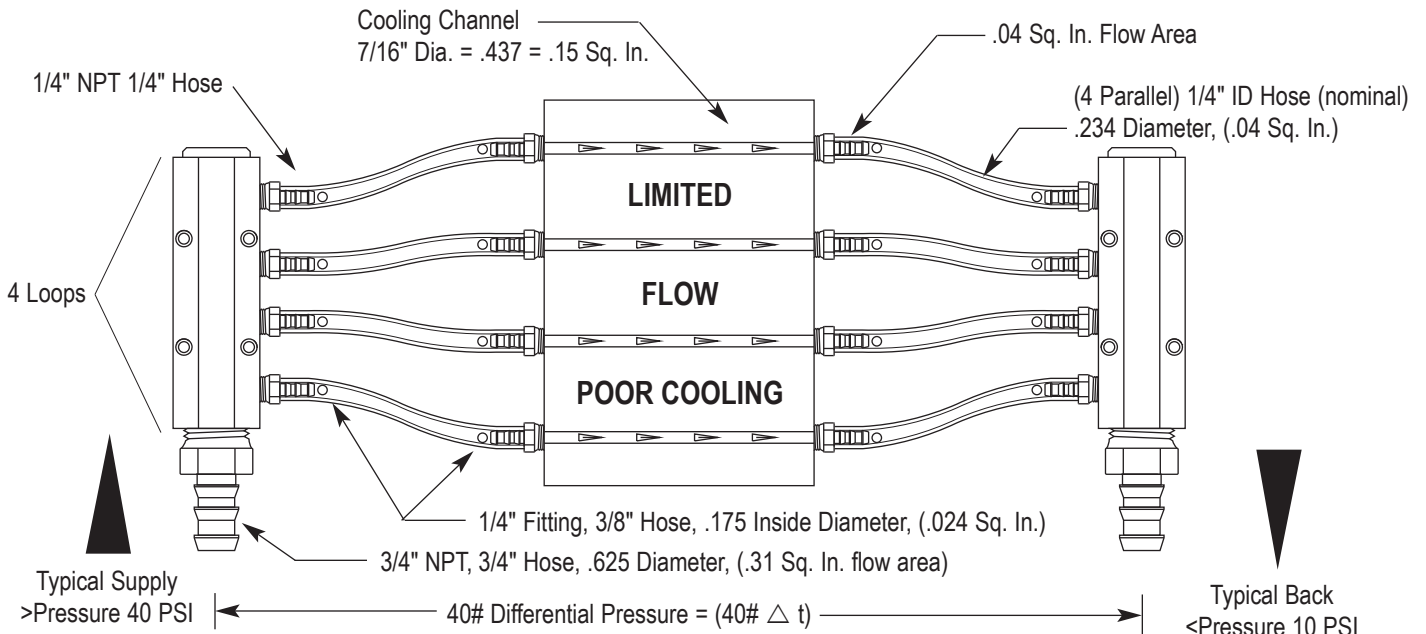

Supply line must be larger than total of all cooling circuits  
(As shown: Supply .31 Sq. In.,  
Loop Fittings 4 x .024 Sq. In. = .096 Sq. In.)

## HIGH PERFORMANCE COOLING USE OF FULL FLOW FITTINGS

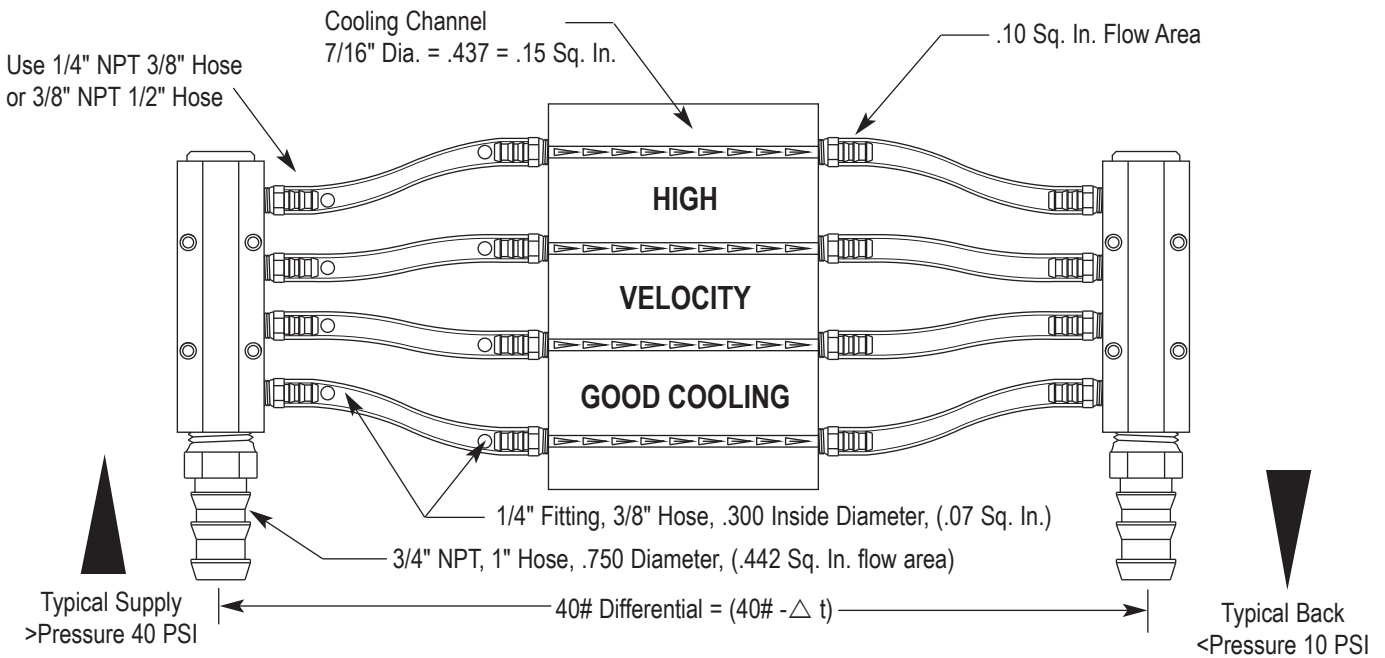

Supply line must be larger than total of all cooling circuits  
(As shown: Supply .442 Sq. In.,  
Fittings 4 x .07Sq. In. = .28 Sq. In.)

CITO-FP-PRICE-23-1120

# Flow Considerations

## Flow Restriction (or Unbalanced) Hook Ups Will Increase Cycle Time

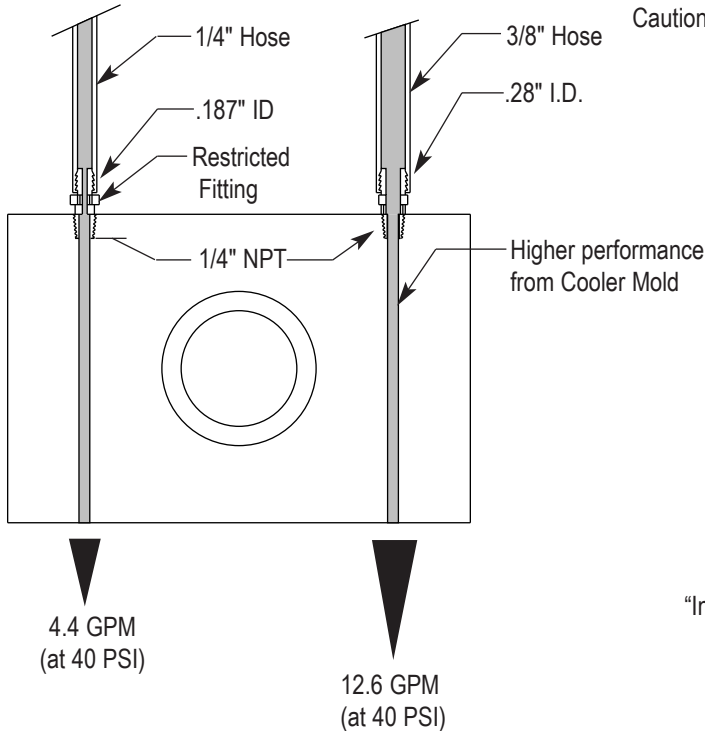

Caution: Unbalanced flow will result from change in flow direction.

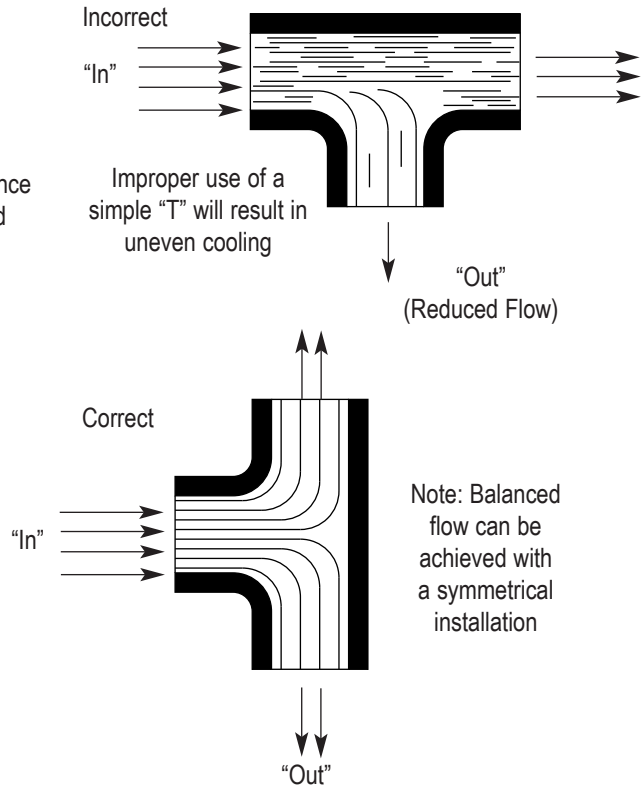

## 200% More Flow Area with High Flow Fittings

A mold will always be limited by its least cooled cavity. Coolant supply area should always be more than total mold ports area to avoid starving the mold of pressure and flow. Pressure difference across the mold should be no less than 40 P.S.I.

Avoid kinked hoses and any other restrictions.

Hose I.O.	Fitting Orifice Size	Area Square Inch	Supply area should exceed total of outlets (area square inch)						
			2 Ports	4 Ports	6 Ports	8 Ports	10 Ports	12 Ports	16 Ports
1/4"	.19"	.03	.06"	.12	.18	.24	.30	.36	.48
3/8"	.28"	.06	.12"	.24	.36	.48	.60	.72	.96
1/2"	.40"	.12	.24"	.48	.72	.96	1.20	1.44	1.92
3/4"	.56"	.25	.50"	1.0	1.50	2.00	2.50	3.00	4.00
1"	.87"	.59							
1-1/4"	1.0"	.78							
1-1/2"	1.25"	1.23							
2"	1.88"	2.7							

Example:  
Supply 1" .59 sq. inch  
3/8" waterlines = .06 square inches  
.56 divided by .06 = up to 9 waterlines

Note: supply .48 sq. in. exceeds total hold cooling channel area

A typical mold with 8 (3/8) cooling circuits can be supplied with a 1" manifold.

CITO-FP-PRICE-20-1023